

Angle Fitting – ZL72

1 Hole 7 7/8" Corner Angle

Standard finish is Electro-Galvanized (EG).

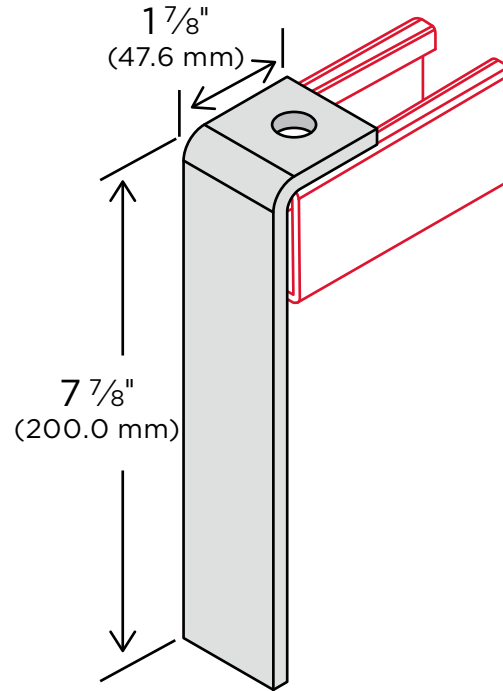

CATALOG NUMBER	WEIGHT
	lbs.
ZL720000EG	1.00

Material is 1 3/8" (41.3 mm) wide x 1/4" (6.3 mm) thick unless specified. Holes are 9/16" (14.3 mm) diameter, 1 3/16" (20.6 mm) center to edge on 1 7/8" (47.6 mm) centers unless specified.

Material Specifications and Finishes

Carbon Steel – ASTM A1011-00 SS GR 33 or ASTM A1011-00CS Type B

EG – Electro-Galvanized. Electroplating deposits zinc on the surface of the steel by electrolysis from a bath of zinc salts. Recommended for relatively dry indoor use. This is the standard coating for most ZI-Strut products. Thickness of applied zinc is between 0.2 mils and 0.5 mils (5.1 μm to 12.7 μm). Coatings on ZI-Strut EG products meet ASTM B633 SC1 Type III.

GN – Green Powder Coat. A Polyester powder coating is electrostatically applied after fabrication. The powder is then baked on creating a 1.38 to 1.77 mil (35 to 45 μm) thick coating. The hardness of this coating meets ASTM D-3363-74, the impact rating meets ASTM D-2794-93 and the gloss meets ASTM D-523-85. This creates a coating that is resistant to chipping, peeling and corrosion. Available in many colors by special order.

HD – Hot Dip Galvanized After Fabrication. Fabricated product is dipped in molten zinc and is completely covered on all surfaces. Recommended for outdoor use. Coatings on ZI-Strut HD products meet ASTM A123/153. The zinc coating is typically 2.6 mils (66.0 μm) or 1.5 oz. per square foot (0.46 kg per square meter) per side.

S4 – 304 Stainless Steel – ASTM A240 (Type 304)

S6 – 316 Stainless Steel – ASTM A240 (Type 316)
316 Stainless Steel Nuts – ASTM A276-03

YC – Yellow Zinc Dichromate. A 0.5 mil (12.7 μm) electro-galvanized zinc plating meeting ASTM B633 SC1 Type III is applied to the surface of the metal. Yellow Dichromate is applied over the zinc. This results in a yellowish gold appearance and acts as a nonporous barrier sealant that is corrosion resistant and can be painted.

Note: Specifications subject to change without notice.

SUBMITTAL INFORMATION

PROJECT: _____ CONTRACTOR: _____ DATE: _____

ENGINEER: _____ SPECIFICATION REFERENCE: _____ SYSTEM TYPE: _____

LOCATIONS: _____ COMMENTS: _____

ZI-120523